

Pile crane for sale Junttan PM23 LC s/n 1513 Year 2008, 15,300 engine hours. Hammer HHK 4/5, Auger borer JD 1,5

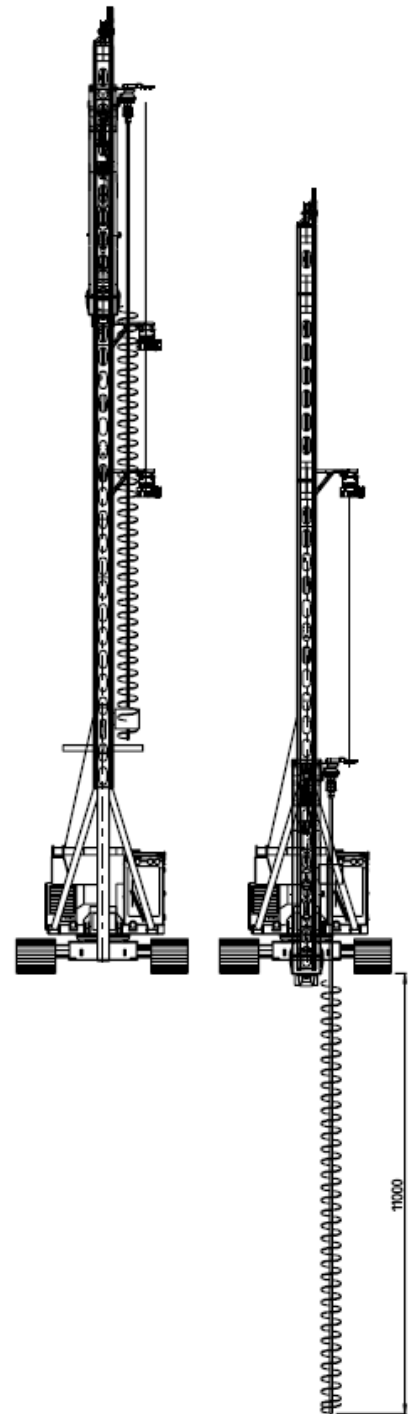

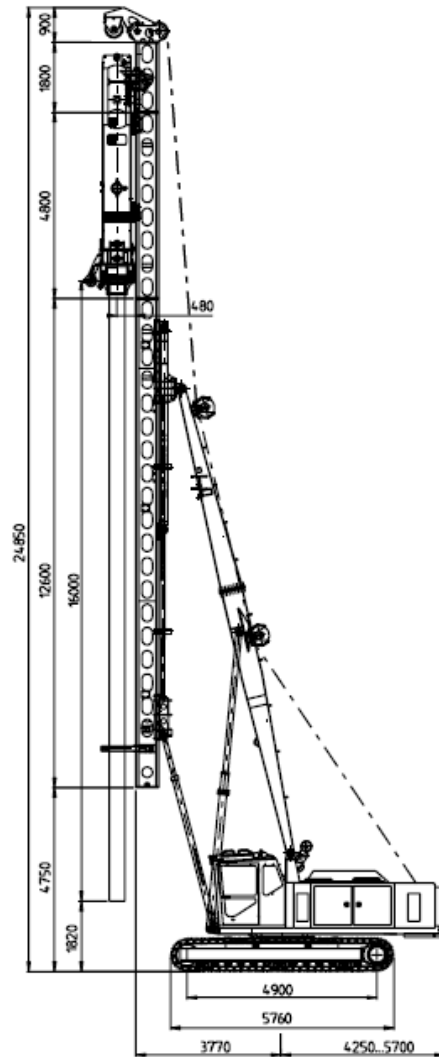

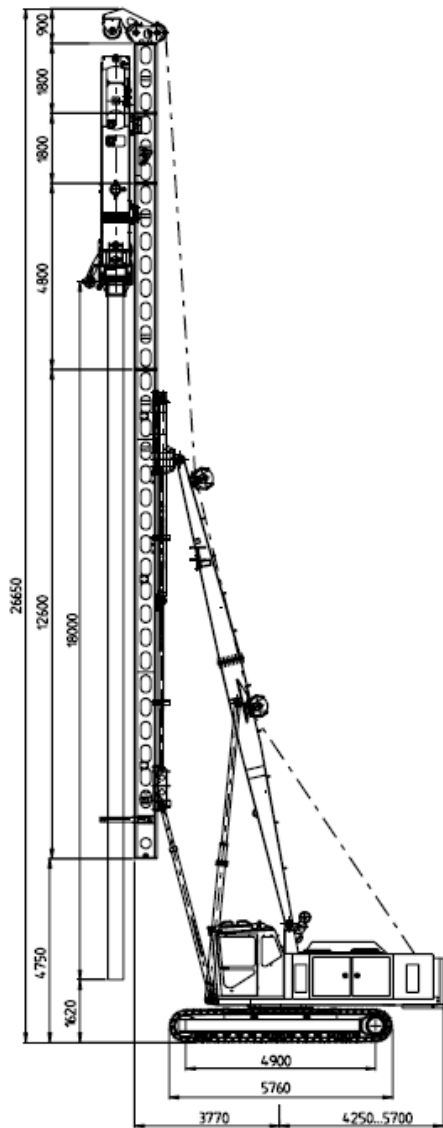





Bild 2b



Bredd och höjd Bild 2c

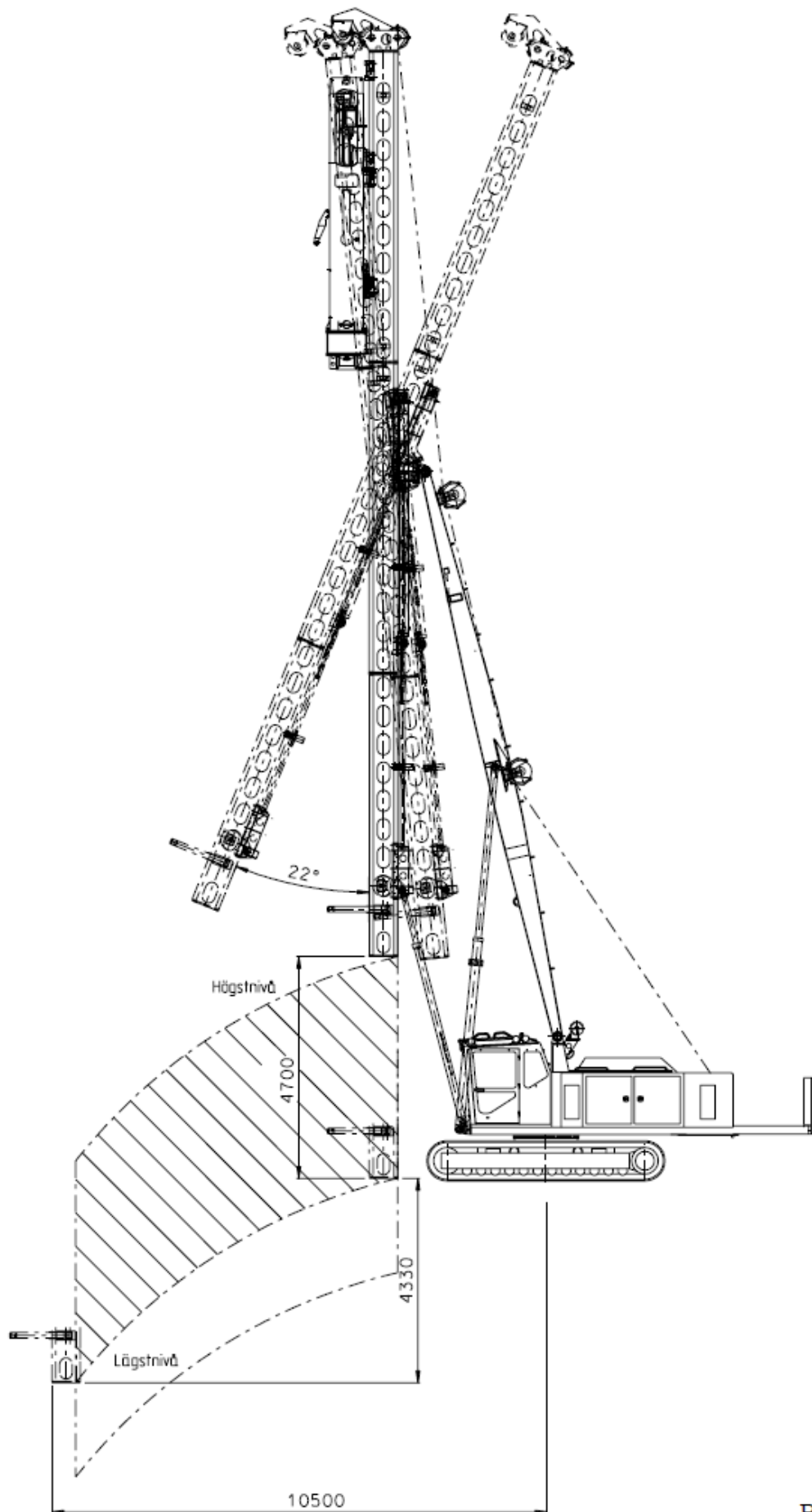
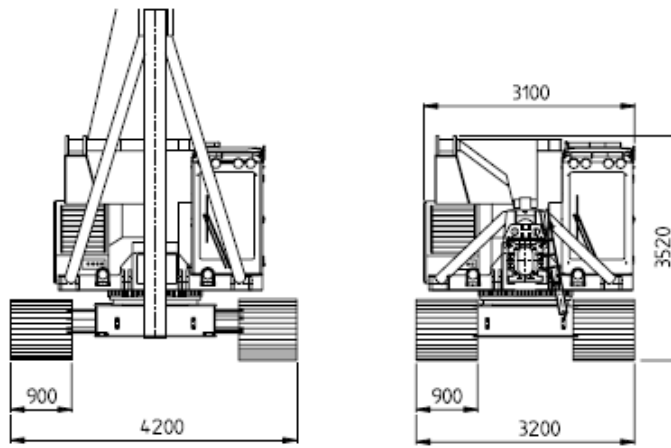
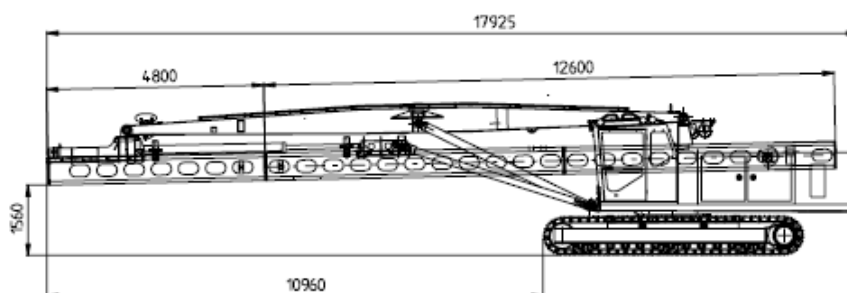

Bild 3

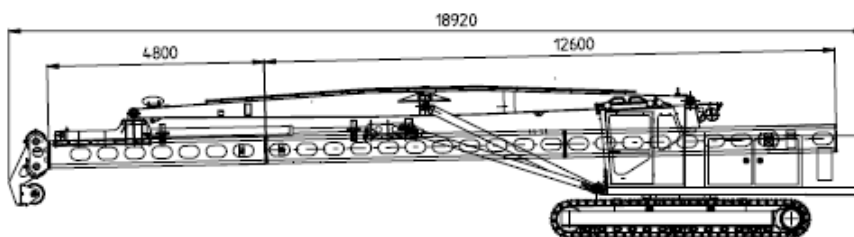
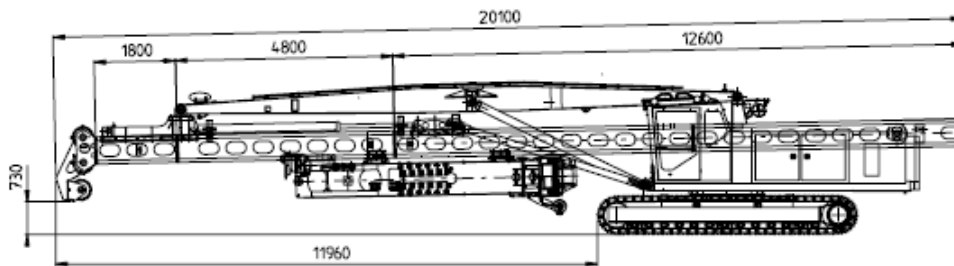
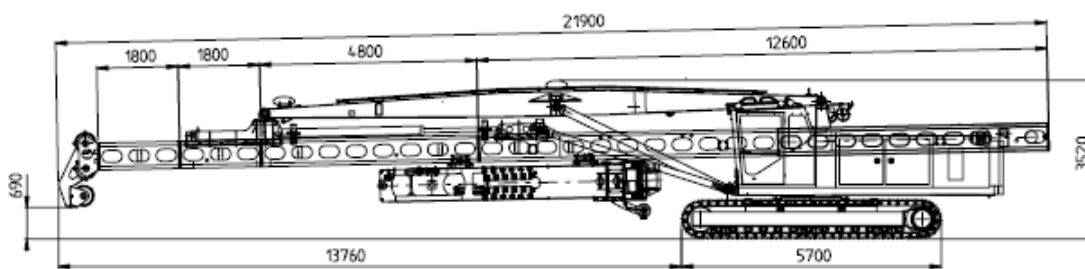